

Stick insect locomotion in a complex environment: climbing over large gaps

Bettina Blaesing* and Holk Cruse

Faculty of Biology, University of Bielefeld, Postbox 100131, D-33501 Bielefeld, Germany

*Author for correspondence (e-mail: bettina.blaesing@uni-bielefeld.de)

Accepted 21 January 2004

Summary

In a complex environment, animals are challenged by various types of obstacles. This requires the controller of their walking system to be highly flexible. In this study, stick insects were presented with large gaps to cross in order to observe how locomotion can be adapted to challenging environmental situations. Different approaches were used to investigate the sequence of gap-crossing behaviour. A detailed video analysis revealed that gap-crossing behaviour resembles modified walking behaviour with additional step types. The walking sequence is interrupted by an interval of exploration, in which the insect probes the gap space with its antennae and front legs. When reaching the gap, loss of contact of an antenna with the ground does not elicit any observable reactions. In contrast, an initial front leg step into the gap that often follows antennal ‘non-contact’ evokes slowing

down of stance velocity. An ablation experiment showed that the far edge of the gap is detected by tactile antennal stimulation rather than by vision. Initial contact of an antenna or front leg with the far edge of the gap represents a ‘point of no return’, after which gap crossing is always successfully completed. Finally, flow chart diagrams of the gap-crossing sequence were constructed based on an ethogram of single elements of behaviour. Comparing flow charts for two gap sizes revealed differences in the frequency and succession of these elements, especially during the first part of the sequence.

Key words: stick insect locomotion, hexapod walking, gap crossing, tactile orientation, exploration, ethogram, *Aretaon asperrimus*, *Carausius morosus*.

Introduction

A fundamental goal of ethological studies is to understand how complex behaviour is controlled. This goal can be achieved by breaking down the continuous flow of activity into single actions that can easily be identified and counted. For investigating the control of adaptive locomotion in a natural environment, analysing the basic elements of the behaviour and their linking is a useful approach. The behaviour performed by insects when climbing over obstacles such as large gaps is a challenging paradigm for investigating the adaptation of locomotion. In spite of its high variability, this behaviour contains a variety of recognisable elements, on the basis of which a concise description of the complete behaviour is still possible.

In several previous studies, insects have been observed when crossing gaps (e.g. Cruse, 1976a, 1979; Duerr, 2001; Watson et al., 2002). The gaps used in these studies, however, were not wider than the corresponding mean step amplitude. Steps observed under these conditions were mainly homogenous regarding their spatial and temporal parameters. In the current study, gap size was deliberately chosen to be larger – two and three times the step length – to challenge the adaptive capabilities of the controller of the insect’s locomotor behaviour. Comparably large gaps relative to body size and step length have only been used by Pick and Strauss (2003) in

order to evaluate the role of visual and tactile orientation in *Drosophila* locomotion. The complex gap-crossing behaviour of the stick insect described here is far beyond the capabilities of any actual hexapod robot. As insect locomotion has proved to be a useful model for the construction of walking machines that have to cope with rough terrain (e.g. Beer et al., 1997; Ritzman et al., 2000; Cruse, 2001), the analysis of the underlying mechanisms may help in the construction of robots with more animal-like abilities.

When facing a large gap, the insect cannot just continue its normal walking pattern; it has to ensure that there is a continuation of the path ahead. In vertebrates such as humans, obstacle avoidance behaviour during walking is mainly guided by vision (Patla et al., 1999). In insects, orientation of the antennae towards visual stimuli has been observed (Honegger, 1981). Tactile exploration can become crucial as an alternative, especially in nocturnal species. Both the antennae and the front legs can be used as tactile probes, and slow-walking stick insect species with long antennae seem to make use of both options. It has been shown that the stick insect *Carausius morosus* uses its front legs as feelers when walking on a horizontal plane (Cruse, 1976b) but also probes the space in front of its body with its antennae (Duerr, 2001).

The role of insect antennae as tactile sensors is impressively

demonstrated in studies of object-guided orientation (Okada and Toh, 2001) and wall-following behaviour (Camhi and Johnson, 1999) in the cockroach. Because of their robustness, insect-like antennae have been used to facilitate fast locomotion and active probing in walking robots (Duerr and Krause, 2002; Cowan et al., 2003). Using the antennae actively for tactile exploration has also been observed in Crustacea such as crayfish, which move their antennae into the walking direction before walking or turning (Zeil et al., 1985) and even localise objects accurately from the received tactile input (Sandeman and Varju, 1988). In agonistic encounters, both crayfish (Bruski and Dunham, 1990) and crickets (Hofmann and Schildberger, 2001) use their antennae for tactile communication.

As an alternative or in addition to the antennae, the front legs are used for tactile exploration by different species. Cockroaches use their front legs to explore the surrounding environment by forward and sideways reaching movements (Watson et al., 2002; Full et al., 1991). Special functions of the front legs compared to the other leg pairs have been demonstrated for curve walking and turning behaviour, to which the front legs of the cockroach contribute more than the middle and hind legs (Jindrich and Full, 1999). In the stick insect, the front legs also play an important role in curve walking by initiating the turning movement (Duerr and Authmann, 2002). Even the 'front legs' of bipedal walkers that have been specialized for other tasks such as grasping like human arms, still play an important role in the stabilisation of walking (Marigold and Patla, 2002; Marigold et al., 2003).

In this article, we will investigate locomotive behaviour during trials with varying gap width and investigate how stick insects mainly examine their path: by vision or by touch received by the antennae or front legs. Subsequently, gap-crossing behaviour from trials with two different gap sizes will be studied in detail by defining basic elements of the sequence and analysing their distribution and frequency. As the temporal structure of the gap-crossing sequence is partly predetermined by physical parameters – the front legs have to cross the gap before the middle legs – a framework of fixed events is used here to subdivide the sequence and to determine the temporal and spatial measures of the resulting sections. Within the different predefined sections of the gap-crossing sequence, the frequency and order of behavioural elements can vary, and single elements can be modified, depending on the actual requirements. This approach is studied with an ethological method by using an ethogram, in which basic elements of gap-crossing behaviour are defined. An ethogram is a catalogue of all actions or 'units' or 'elements' of behaviour that are observed in the general or special behavioural repertoire of a species (Immelmann and Beer, 1989). It consists of categories of behaviour that are objective, discrete, do not overlap with each other and allow for the behaviour to be described as completely and precisely as possible. Ethograms are used in descriptive behaviour studies to analyse sequences of behaviour. Early examples can be found in the work of Tinbergen (1951), more recent examples are studies of bird song (e.g. Bradley and Bradley, 1983) or locomotor behaviour (Berridge, 1990). In

insect studies, ethograms have mainly been used to describe social (Hoelldobler and Wilson, 1990) or agonistic behaviour (Hoffmann, 1987; Hofmann and Schildberger, 2001). Burrows and Morris (2002) show choice trees based on an ethogram of different avoidance and escape behaviours in *Sipylodea* sp. The ethogram of gap-crossing behaviour used in the current study consists of different types of steps that have been classified according to their swing amplitude and the context in which they occur. It does not include all elements of the behavioural repertoire of the stick insect, only the ones that are necessary to describe the walking and gap-crossing behaviour relevant for this study. In another article, we compare gap-crossing behaviour to undisturbed walking on the basis of single step parameters such as the swing amplitude and extreme positions of single steps (Blaesing and Cruse, 2004).

The studies of stick insect behaviour different from walking are rather limited; a brief review can be found in Burrows and Morris (2002). Whereas most studies of stick insect locomotion have used the species *C. morosus* for investigation, *Aretaon asperrimus* was preferred here, as previously by Cruse and Frantsevich (1997). This species walks slowly but more steadily than *C. morosus* and climbs readily over obstacles and gaps. During undisturbed walking, it scans the ground more intensely with its antennae than *C. morosus* (Duerr and Blaesing, 2000). *A. asperrimus* is better camouflaged when sitting on the ground or on stems of trees than on leaves and twigs (for a species description, see Bragg, 2001). The morphology of the species and personal qualitative observations suggest that this species hides close to the ground or on bark during the day, from where it moves up to the leaves to forage at night. As *A. asperrimus* is not able to jump or fly like other insect species that inhabit a comparable environment, it depends on its ability to walk and climb in the foliage. Accordingly, the species shows a high motivation for exploration and crossing gaps and obstacles. This behaviour makes *A. asperrimus* a suitable biological model for adaptive walking in a complex environment. By investigating its performance in the gap-crossing paradigm, we hope to contribute to our understanding of the control of adaptive locomotion in insects and its application for autonomous artificial agents that are thought to perform locomotive tasks in a natural environment.

Materials and methods

Animals

Stick insects of the species *Aretaon asperrimus* Rethenbacher 1906 were kept in mesh wire cages on bramble (*Rubus fruticosus*) and water *ad libitum* with an artificial day:night cycle of 12 h:12 h. Body length was 51 ± 1.0 mm (mean \pm s.d.) in males ($N=12$ animals) and 76 ± 3.0 mm in females ($N=10$). Males and females were treated separately in the first experiment due to their different size and body geometry. For the second experiment and the detailed analysis of the gap-crossing sequence, only male subjects were used because of their higher agility. The average step amplitude of

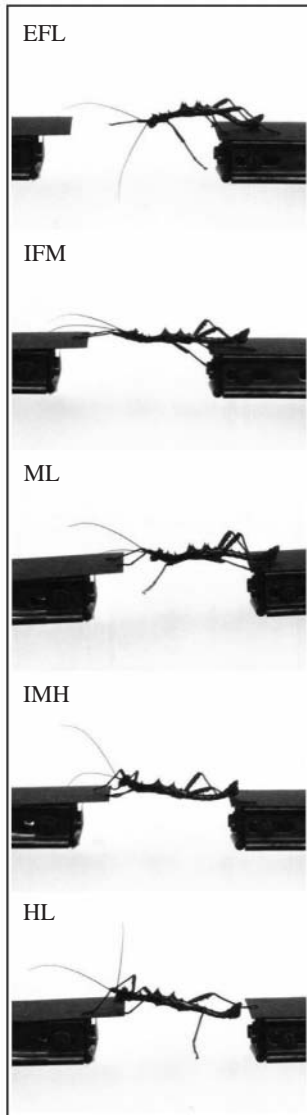

Fig. 1. Consecutive photographs (from top to bottom) of *Aretaon asperrimus* male climbing across a gap of 50 mm width between two cardboard footbridges; each picture illustrates one of the sections of the gap-crossing sequence. EFL, exploration and front leg gap-crossing steps; IFM, interval between front leg and middle leg gap-crossing steps; ML, middle leg gap-crossing steps; IMH, interval between middle leg and hind leg gap-crossing steps; HL, hind leg gap-crossing steps.

males is approximately 17 mm (front legs: 17.1 ± 2.6 mm, $n=310$, middle legs: 16.8 ± 2.7 mm, $n=326$, hind legs: 17.6 ± 2.4 mm, $n=340$). Distances between the coxae of adjacent leg pairs are 10.1 ± 1.2 mm between the middle and front leg coxae and 7.0 ± 0.7 mm between the hind and middle leg coxae ($N=10$).

Experimental set-up

In all experiments, animals were placed on a cardboard footbridge of 60 mm width, 300 mm length and 200 mm height, facing a second footbridge of the same type. The gap between the two footbridges was variable; an example of a trial with 50 mm gap width is shown in Fig. 1. The animals were recorded from a distance of 1.5 m by an overhead video camera (Sony EVI-D31). A simultaneous side view image of the walking animal was obtained *via* a mirror attached to the footbridges at a 45° angle. Video recordings (50 frames s^{-1}) were carried out in daylight with additional artificial lighting. Recordings of the gap-crossing sequence were analysed in

slow motion and single frame modus, using customized software designed to read marked pixel coordinates as ASCII data. Data analysis and statistical tests were carried out using Origin (Microcal, Northampton, MA, USA) and SPSS software.

Experimental procedure

In the first experiment, the insects (5 males, 3 females) were tested with gaps of 20, 30, 40, 50 and 60 mm width. Each animal was tested in 20 trials per gap size, presented in random order. A trial was counted as successful only if the animal had crossed the gap. In a control experiment (4 males, 4 females), a paper-strip of corresponding width was used instead of a gap. Duration was measured as number of frames from the first antennal contact with the ground behind the gap or paper-strip to the touchdown of the sixth leg behind the gap or paper-strip. Antennal exploration before discovering the second footbridge was not taken into account. In the second experiment, six males were reversibly blindfolded with solvent-free black ink and tested in the same task. Individual animals started either sighted or blindfolded. Additionally, six males with shortened antennae (between 15 and 28 mm) but intact vision were tested in the same set-up.

In the following experiments, gap-crossing behaviour was analysed in more detail. Two gap sizes were chosen: 30 mm ($N=7$ animals, $n=15$ trials) and 50 mm ($N=5$, $n=10$).

Definition of step types

In the description of individual steps, the terms 'posterior extreme position' (PEP) and 'anterior extreme position' (AEP) describe the lift-off and touchdown position of the leg in a body-fixed coordinate system, respectively. The position at which the tarsus moves below footbridge level when swinging into the gap has been called 'fictive AEP' (fAEP) by Duerr (2001). The swing amplitude is defined as the length of the vector that points from the PEP to the AEP of the same swing movement. All individual steps recorded from the trials were assigned to the following four categories: (1) tentative steps, (2) gap-crossing steps, (3) normal walking steps and (4) short steps (Fig. 2). Tentative steps consist of swing movements into the gap followed by pulling the tarsus back and placing it onto the first footbridge. Gap-crossing steps are characterised by a swing trajectory that connects the first to the second footbridge. Normal walking steps and short steps were defined according to their swing amplitude and swing direction in a body-fixed coordinate system. For classification as normal walking steps, steps had to fulfil two conditions: (1) a minimum swing amplitude of 8.5 mm and (2) forward direction of the swing movement. The latter criterion, forward direction of the swing movement, was met if the AEP was located rostral of the PEP within an angle of $\pm 45^\circ$ relative to the body long axis in a body-fixed coordinate system. Steps of more than 8.5 mm amplitude that did not fulfil this criterion were so rare that they were not considered in the analysis. All steps with an amplitude of less than 8.5 mm were assigned to the group of short steps, regardless of their swing direction. The threshold of 8.5 mm was chosen based on the distribution of amplitudes of all steps

observed during gap crossing and undisturbed walking (Fig. 3). As an example of the typical distribution of the four defined step types, stepping patterns of an individual 30 mm gap-crossing trial and a sequence of undisturbed walking are displayed in Fig. 4.

Sections of the gap crossing sequence

To subdivide the temporal sequence of gap-crossing behaviour, six events that occur in a fixed order were defined. These events are (1) the first ‘non-contact’ of an antenna with the gap (see below), (2) reaching the AEP of the gap-crossing step of the second front leg, (3,4) the PEP of the first and the AEP of the second middle leg gap-crossing step and (5,6) the PEP of the first and the AEP of the second hind leg gap-crossing step. By using these six events as a framework, the sequence of gap-crossing behaviour was divided into the following five sections (Fig. 1): EFL (exploration/front legs cross the gap) – this section includes antennal and front leg exploration movements and front leg gap-crossing steps; it starts when the tip of an antenna moves below the line that connects the two footbridges (‘antennal non-contact with the gap’) and ends when both front legs are placed on the second footbridge; IFM (front leg/middle leg interval) – from the touchdown of the second front leg gap-crossing step to the lift-off of the first middle leg gap-crossing step; ML (middle legs cross the gap) – from the lift-off of the first middle leg gap-crossing step to the touchdown of the second middle leg gap-crossing step; IMH (middle leg/hind leg interval) – from the touchdown of the second middle leg gap-crossing step to the lift-off of the first hind leg gap-crossing step; HL (hind legs cross the gap) – from the lift-off of the first hind leg gap-crossing step to the touchdown of the second hind leg gap-crossing step. For these sections, duration, advance of the body over ground and forward velocity of the body were measured and the distribution of the step types defined above was determined. Duration was calculated as time difference between the first and the last frame

of the section. Advance was measured as the distance between the position of the body centre of mass (between the hind leg coxae) in the first and in the last frame of each section in an external coordinate system. Velocity of body movement over ground was calculated by dividing body advance by duration.

Ethogram and bigram analysis

Finally, an ethogram (Fig. 5) was used to analyse the sequence of gap-crossing behaviour on the basis of its single elements and their order. It includes the four previously defined step types and three elements of antennal and front leg exploration. As gap-crossing steps and tentative steps have a more variable structure than walking steps and short steps, the former have been broken down into finer parts: the elements ‘swing’ and ‘search’ occur in both step types, but tentative steps are completed by placing the leg back on the first footbridge (‘AEP fbr_1’), whereas gap-crossing steps are completed by placing the leg on the second footbridge (‘AEP fbr_2’).

For analysing the sequence of the single elements of gap-crossing behaviour, the concept of bigrams has been adopted from computer linguistics (e.g. Jurafsky and Martin, 2000). A bigram is a pair of two elements that directly follow each other in a naturally occurring sequence. This means that each element (except for the first and the last one of the sequence) is recorded twice, with its preceding and following neighbour (for example the sequence ABCD consisting of elements A, B, C and D results in bigrams AB, BC and CD). The resulting pairs, the bigrams, are then treated as new basic units in the analysis. In the current study, all elements of behaviour have been listed in the order of their occurrence for every trial. From this list, all pairs of two elements that directly follow each other have been defined as bigrams and have been used as basic units in the following analysis. The frequency of bigrams was counted; 30 mm trials and 50 mm trials were treated separately. In total, 1194 bigrams were counted in the 30 mm trials and 971 in the

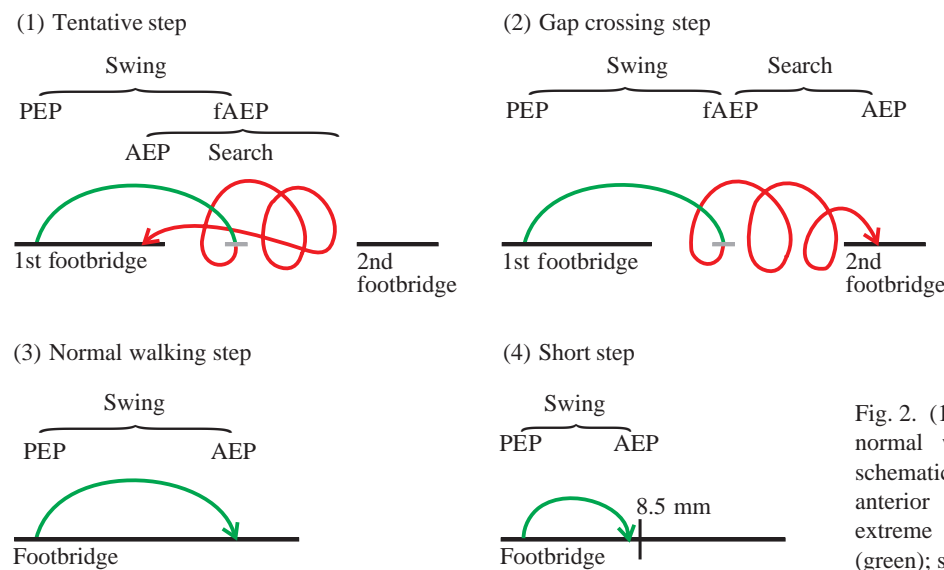

50 mm trials. 461 different types of bigrams (AB is a different type of bigram compared to BA or BC) occurred in the 30 mm trials and 387 in the 50 mm trials. We tested the hypothesis that certain bigrams occur more often in the observed behaviour than in a random distribution (if the raw data contain 10 A, 20 B and 70 C, the bigrams AB and BA would be expected to occur twice each and AC and CA seven times each if the elements A, B and C were randomly

Fig. 2. (1) Tentative step, (2) gap-crossing step, (3) normal walking step and (4) short step, shown schematically. PEP, posterior extreme position; AEP, anterior extreme position; fAEP, fictive anterior extreme position; swing, initial swing movement (green); search, subsequent searching movement (red).

distributed). The expected probability of any bigram in a random distribution was calculated by contingency tables (see M. Moens and C. Brew, 2000: *Data-intensive Linguistics*. <http://www.ltg.ed.ac.uk/~chrisbr/dilbook/>) and compared to the observed probability by χ^2 -tests. Only bigrams that occurred more than twice in the data and significantly more often than expected in a random distribution ($\chi^2 > 10.84$, $P \leq 0.001$) were included in the analysis.

Results

Variation of gap size

In the first experiment, we studied how the success rate and duration of gap-crossing behaviour depends on gap width. Walking across paper-strips of corresponding width was used as control. The percentage of successful trials and the average duration of crossing gaps and walking over paper-strips is displayed in Table 1. Males and females successfully crossed gaps of 20 and 30 mm in almost every trial ($\geq 97\%$). The success rate decreased from about 40 mm gap width in the males and 50 mm gap width in the females. Males needed more time to cross gaps of the same width than females, with exception of 20 mm gaps. The time difference between crossing gaps and crossing paper-strips of corresponding width increased approx. exponentially with gap size in the males. In the females, the time difference hardly increased up to 50 mm gap width. In separate experiments, no effect of previous experience was observed with respect to duration of the sequence in insects repeatedly crossing gaps of the same width ($N=8$ animals, $n=20$ trials per animal and gap width).

Sensory orientation

In a second experiment we tested which sensory mode is used for detecting the far edge of the gap before climbing across it. Both the visual and the tactile sensory systems could be used by the insect to gain information about a possible continuation of the path. The results of this experiment show that blindfolding has neither any significant effect on the number of successfully completed trials (Table 2) nor on the duration of gap crossing (data not shown). The gap-crossing sequence was abandoned in 85 out of 480 cases (17.7%) in the sighted animals (A+V+) and in 84 out of 480 cases (17.5%) in the blindfolded animals (A+V-), both groups with intact antennae. This consistency shows that vision is not necessary for detecting the far edge of the gap, which suggests that antennal contact with the second footbridge provides sufficient information. Having touched the second footbridge with a front leg, the gap-crossing sequence was always successfully completed regardless of the animal's visual situation.

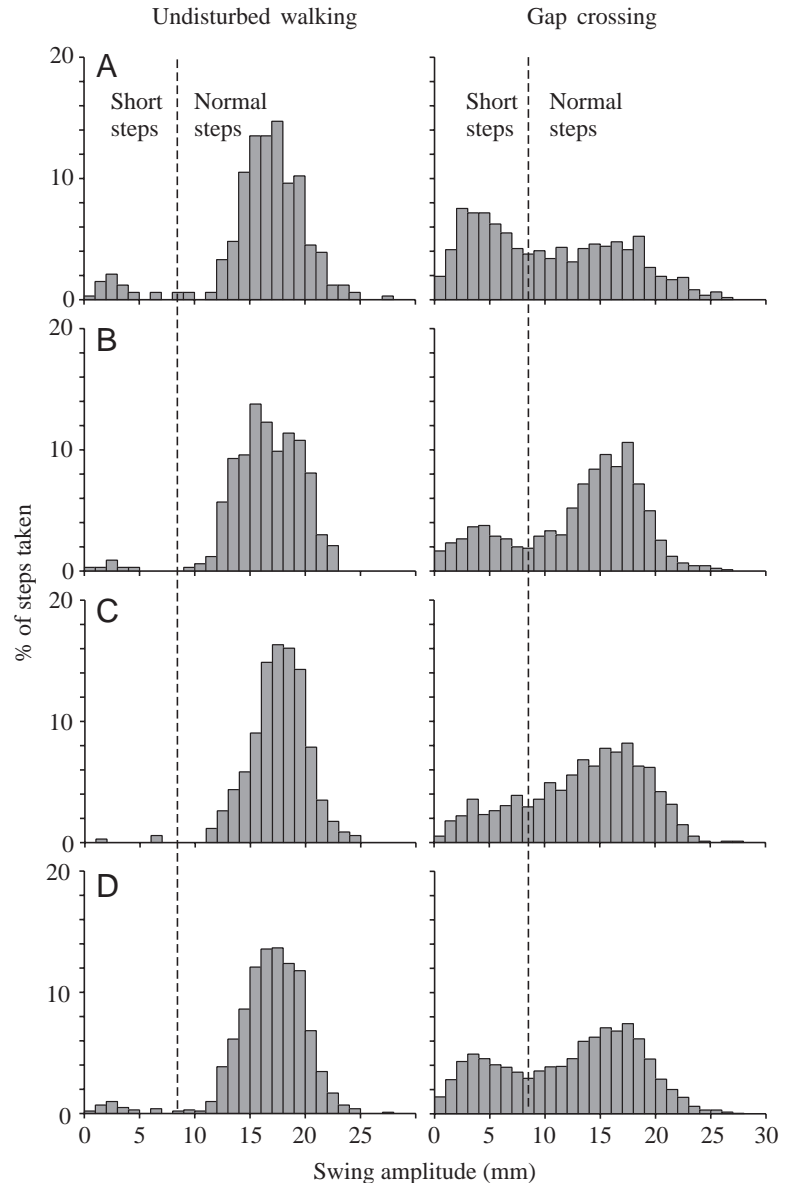

Fig. 3. Histograms of swing amplitudes of all steps (with exception of gap-crossing steps and tentative steps) observed during undisturbed walking (left) and gap crossing (right). (A) Front legs, (B) middle legs, (C) hind legs, (D) pooled data of all leg pairs. The broken lines mark the threshold of 8.5 mm that separates short steps from normal walking steps (as indicated).

Sighted animals with shortened antennae (A-V+) crossed the gap only if they could still reach the second footbridge with an antenna or a front leg. This means that in every successful trial in this group the animal had touched the second footbridge with its shortened antenna (one individual with extremely short antennae regularly touched the far edge of the 30 mm gap with the stretched front leg, which also resulted in gap-crossing behaviour). Because of the restricted working space of their antennae, animals of this group performed fewer successful trials, especially with larger gap sizes than animals with intact antennae. Gap crossing was abandoned in 205 out of 480 trials (42.7%). In only two of

these cases, gap-crossing behaviour was terminated after antennal contact with the second footbridge had already occurred. This behaviour was not observed in any trial of the two groups with intact antennae.

Detailed analysis of gap-crossing behaviour

Analysis of 30 mm and 50 mm gaps revealed that after stepping into the gap with one or both front legs, the insect decreases its stance velocity to almost zero (Fig. 6). Additional forward movement consists of short stops alternating with bouts of slow advance while the antennae perform extensive exploration movements. After reaching the second footbridge with the front legs, body velocity is gradually accelerated throughout the sequence. In Fig. 6, slowing down of body velocity is shown in relation to the first ‘non-contact’ of the front leg (Fig. 6A) and the first ‘non-contact’ of the antenna (Fig. 6B). The relation of slowing down after stepping into the gap with the front leg is more obvious. In the observed trials, antennal ‘non-contact’ takes place between 0 and 30 ms before stepping into the gap with the front leg.

The gap-crossing sequence has been subdivided into five sections EFL, IFM, ML, IMH and HL (Fig. 1; explanation in Materials and methods). Duration, advance of the body overground and velocity of body movement for these sections are displayed in Fig. 7. For the entire gap-crossing sequence, the animals

needed approximately 6 s in the 30 mm trials (mean ± S.D.=5.9±2.2 s) and six times longer in the 50 mm trials

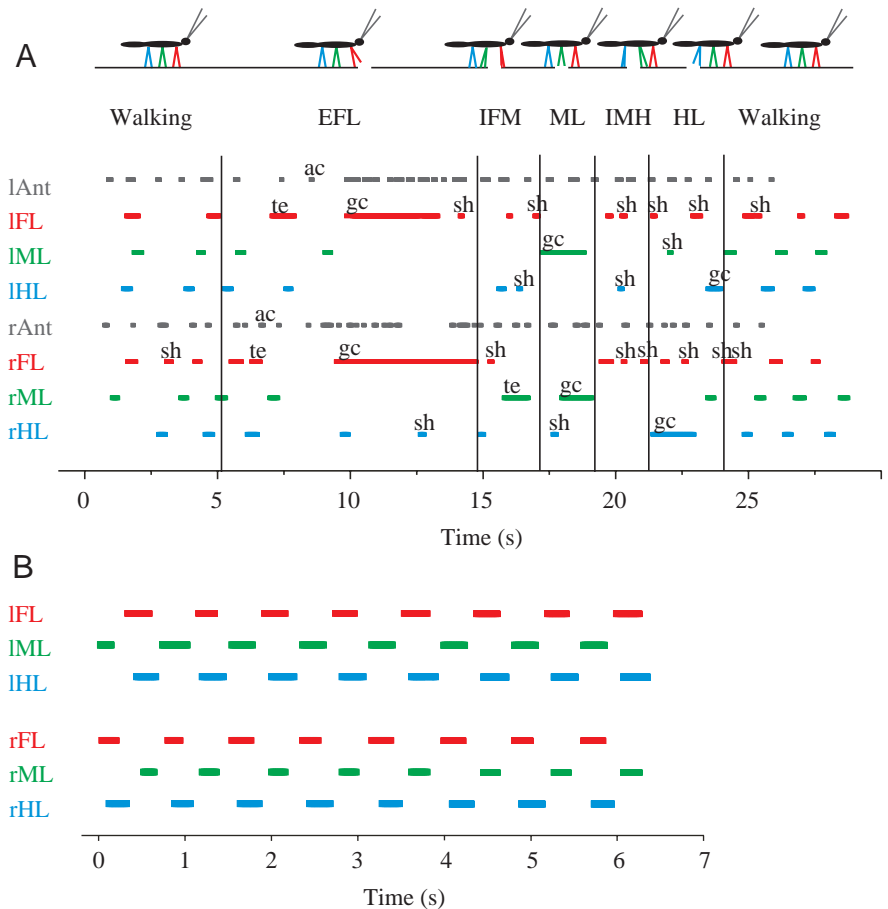

Fig. 4. Examples of stepping patterns. (A) Gap crossing, (B) undisturbed walking. Grey bars, ground contacts of antennae; coloured bars, swing movements of legs. FL, front leg (red); ML, middle leg (green); HL, hind leg (blue); l, left; r, right; ac, first contact of the antennae with the second footbridge; gc, gap-crossing step; te, tentative step; sh, short step. Normal walking steps are not marked. In A, the defined sections of gap-crossing behaviour (see Fig. 1) are separated by vertical lines.

Table 1. Mean duration and success rate of stick insects climbing over gaps and walking across paper-strips

	Length of crossing (mm)									
	20		30		40		50		60	
	Duration (s)	% Successful	Duration (s)	% Successful	Duration (s)	% Successful	Duration (s)	% Successful	Duration (s)	% Successful
Gap										
Males	4.8±1.4	97	8.0±3.8	98	17.7±13.5	81	56.7±56.3	48	–0	
Females	6.6±2.4	100	6.8±2.2	97	9.4±2.0	97	10.2±0.4	72	24.9±4.8	32
Paper-strip										
Males	3.1±0.8	100	4.0±1.4	100	4.5±2.4	100	5.3±2.5	100	5.6±1.9	100
Females	5.3±0.9	100	6.0±1.3	100	7.2±1.6	100	7.3±1.2	100	8.7±1.5	100

Values are means ± S.D.

N=5 males, 3 females for gap crossings; N=4 males, 4 females for paper-strip crossings. n=20 trials per animal and gap size.

Mean body length = 51±1.0 mm (males), 76±3.0 mm (females) (see Materials and methods).

Table 2. Numbers and percentages of successfully completed gap crossing trials in males with intact antennae, sighted (A+V+) and blindfolded (A+V-), and animals with defective antennae, sighted (A-V+)

	Length of crossing (mm)							
	20		30		40		50	
	Number	%	Number	%	Number	%	Number	%
Intact antennae								
A+V+	117	98	118	98	97	81	63	53
A+V-	120	100	119	99	104	87	53	44
Defective antennae								
A-V+	119	99	93	78	45	38	18	15

$N=6$ animals each for intact and defective antennae; $n=20$ trials per animal and gap size.

Note that animals only crossed the gap in trials in which they had received tactile input by the antennae (or in one case of A-V+ by the front legs, as described in the text).

(37.1 ± 26.2 s). Section EFL takes almost 10 times longer in the 50 mm trials (26.3 ± 21.5 s) than in the 30 mm trials (2.8 ± 1.2 s) whereas the rest of the sequence takes only about three times longer. Forward movement of the body overground mainly takes place during EFL, ML and HL, the largest difference between 30 mm and 50 mm trials occurring during EFL (50 mm: +10 mm) and HL (50 mm: +5 mm). In the 50 mm trials, the animals move more slowly than in the 30 mm trials. Mean velocity in the 30 mm trials (15.7 ± 4.4 mm s⁻¹, measured from the beginning of EFL to the end of HL) is about 50% of the velocity of undisturbed walking (30.0 ± 3.4 mm s⁻¹, $N=10$), whereas in the 50 mm trials only 12% of normal walking velocity is reached (3.8 ± 2.5 mm s⁻¹). During EFL, velocity is five times higher in the 30 mm trials than in the 50 mm trials, whereas it is only twice as high during the rest of the sequence.

All of the observed steps have been assigned to four categories, namely gap-crossing steps, tentative steps, short steps and normal walking steps (Fig. 2; see explanation in Materials and methods). The average frequency of the four step types in each section is displayed in Fig. 8. There is no qualitative difference between 30 mm trials and 50 mm trials. In the 50 mm trials, more short steps can be observed compared to the 30 mm trials. For the short steps, this is particularly obvious for the middle and hind legs. Tentative steps are only different from gap-crossing steps regarding the end of their searching movement. They occur most often in the front legs in section EFL. In the front legs, the number of tentative steps approximately equals the number of the gap-crossing steps in both data sets, reflecting that on average, every second step into











Exploration Ant, FL	Contact fbr_2		Antenna touches the second footbridge for the first time
	Contact fbr_2		Front leg touches second footbridge for the first time
Tentative step FL, ML, HL	Swing		Leg swings into the gap
	Search		Leg passes fAEP after swinging into the gap
	AEP fbr_1		Leg is placed on the first footbridge
Gap crossing step FL, ML, HL	Swing		Leg swings into the gap
	Search		Leg passes fAEP after swinging into the gap
	AEP fbr_2		Leg is placed on the second footbridge
Normal walking step FL, ML, HL	Norm		Step on plane surface, amplitude > 8.5 mm
Short step FL, ML, HL	Short		Step on plane surface, amplitude < 8.5 mm

Fig. 5. Ethogram of gap-crossing behaviour; elements of behaviour used in the flow chart diagram (Fig. 10) are printed red. Ant, antenna; FL, front leg; ML, middle leg; HL, hind leg; fbr_1, first footbridge; fbr_2, second footbridge; norm, normal walking step; AEP, anterior extreme position; fAEP, fictive anterior extreme position; swing, initial swing movement; search, subsequent searching movement.

the gap results in reaching the far edge. In the middle legs, tentative steps are far less frequent than in the front legs, and no tentative steps were observed in the hind legs. The number of normal walking steps decreases before and increases after the legs have performed their gap-crossing steps.

Below, short steps of the 30 mm trials ($N=242$ short steps) are considered in more detail to gain information regarding

their function. Three types of short steps can easily be characterised according to the context in which they occur. The first type has been described as levator reflex by Dean and Wendler (1982): if the insect hits an obstacle with its tarsus or the end of the tibia, the leg is pulled up and placed on the ground again. During gap crossing, the levator reflex has been observed in the front and middle legs in response to hitting the side edge of the footbridge (front legs: EFL 5 steps, IFM 7 steps, IMH 5 steps, HL 2 steps; middle legs: EFL 6 steps). Another reflex can be observed if the tarsus hits the anterior leg during the swing movement or is placed on the anterior tarsus. In this case the posterior leg is pulled up and placed slightly backwards [treading on tarsus (TOT) reflex; Graham, 1979; Schmitz and Hassfeld, 1989]. During gap crossing, the TOT-reflex mainly occurred during EFL in the middle legs (5 cases) or while the animal was trying to place the leg on the second footbridge (middle leg: 11 cases during ML and IMH, hind leg: 3 cases during HL). A third group of short steps occurred directly after the tarsus had reached the second footbridge and was clinging to the edge with the unguis rather than standing in a stable position. In this situation, short steps were apparently used to place the tarsus on the footbridge surface. This situation occurred 20 times in the front legs, 3

times in the middle legs and 8 times in the hind legs. The distribution and the relative swing direction (AEP relative to the PEP) of the remaining 166 short steps is displayed in Fig. 9. The majority of these short steps (83 steps) were performed by the front legs throughout the entire sequence, especially during IMH and HL. During section EFL, more short steps were performed by the middle legs and hind legs than by the front legs. Most of these short steps were directed to the front and, in the middle legs, also to the side, presumably contributing to slow forward movement and slight side shifting of the body long axis to support front leg searching. During sections IFM to HL, most short steps were performed by the front legs, mostly directed to the front and to both sides, and only few short steps occurred in the middle and hind legs.

The temporal sequence of the different behavioural elements is illustrated in the flow chart diagram of gap-crossing behaviour (Fig. 10). This flow chart is more complex than a choice tree, as the sequence of behavioural elements in gap-crossing behaviour often contains loops, and bifurcations can occur at any time. To make the temporal structure more perspicuous, the most frequent associations between single elements of behaviour (Fig. 5) are displayed in the framework of the three sections EFL, ML and HL. In general, more

different transitions occur in the 30 mm trials (red and black arrows in Fig. 10) than in the 50 mm trials (green and black arrows in Fig. 10), in which the body position of the animal and therefore the number of possible subsequent movements is more restricted. This difference is more obvious in the middle and hind legs than in the front legs. Only in the 30 mm trials, transitions between 'AEP fbr_2' and 'swing' or 'search', i.e. red arrows pointing upward, occur in every leg pair. In the 50 mm trials, middle leg swinging is less often directly followed by the contralateral middle leg reaching the first or second footbridge. After placing a front leg on the first or (in the 30 mm trials) on the second footbridge, the contralateral front leg often immediately begins a swing movement. In the 50 mm trials, front leg searching is often accompanied by a short step of the hind leg.

Antennal contact with the second footbridge occurred in different situations in the 30 mm and 50 mm trials. In the 30 mm trials, the antenna was likely to touch the second footbridge while searching with a front leg during a tentative step. Therefore antennal contact with the

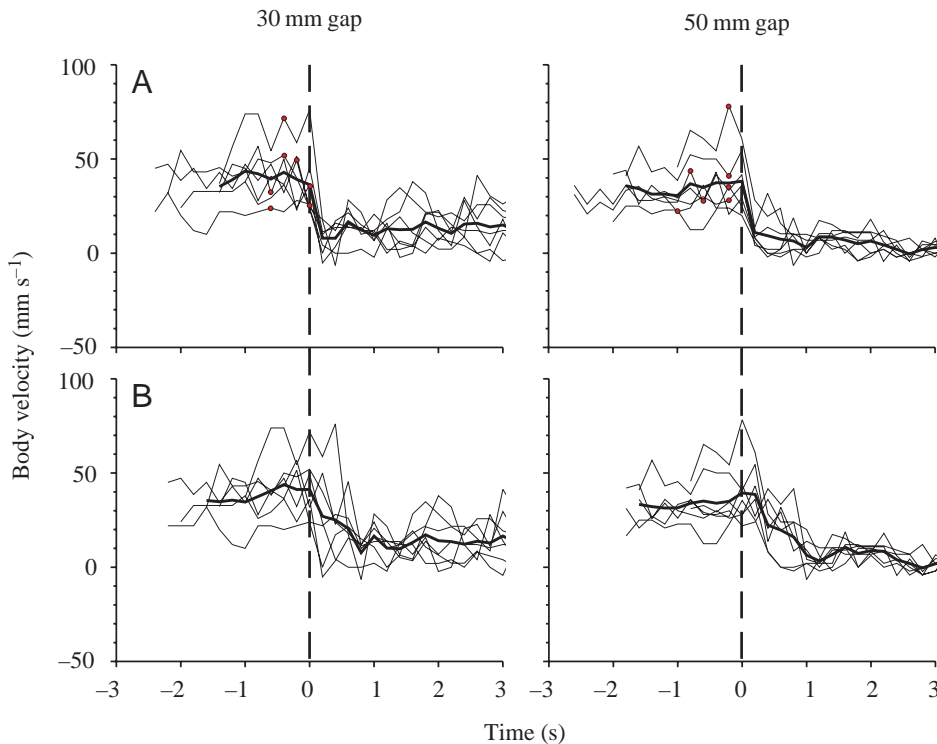

Fig. 6. Velocity profiles of forward movement of the body overground during a time window of 6 s at the beginning of the gap-crossing sequence. (A) $t=0$ (broken line) taken as initial 'non-contact' of the front leg (tarsus crosses footbridge level while swinging into the gap for the first time); (B) same data as in A, but $t=0$ (broken line) taken as initial 'non-contact' of the antenna. Heavy lines, arithmetic mean; thin lines, single trials; red dots in the upper panel mark 'non-contacts' of the antenna ($t=0$ in B), illustrating their temporal relation to corresponding 'non-contacts' of the front leg. Left, 30 mm trials; right, 50 mm trials; $N=7$ trials in each gap width, bin width=200 ms.

second footbridge was commonly followed by 'AEP fbr_1'. This was not the case in the 50 mm trials, as the body centre of mass had to be pushed too far forward for placing the front leg back onto the first footbridge before the second footbridge could be reached by an antenna. In the 50 mm trials, antennal contact with the second footbridge regularly occurred after finishing a middle leg tentative step and before the front legs reached the second footbridge. This observation reflects a tendency of front leg gap-crossing steps and middle leg tentative steps to overlap when crossing extremely large gaps.

Discussion

The aim of this study was to describe how locomotion is adapted to the challenges of a complex environment. The behaviour of stick insects climbing over large gaps has proved to be a useful paradigm to approach this question: it is based on a well-studied object, stick insect walking behaviour on even ground, and the 'environment' can easily be varied in a controlled way by changing the size of the gap. The species *A. asperrimus* is particularly suited for this study because it appears to be highly motivated to cross even large gaps.

The results of the study show that during gap-crossing behaviour, steps vary more strongly than during undisturbed walking. In addition to normal walking steps and gap-crossing steps, tentative steps and short steps have been observed. The number of both step types was higher in trials with a larger gap and decreased from the front to the hind legs (Fig. 8).

Tentative steps especially of the front legs occurred almost exclusively during section EFL, the first part of the sequence that includes antennal and front leg exploration movements and front leg gap-crossing steps. Front leg tentative steps are closely related to gap-crossing steps. Both step types start in the same way with a swing movement into the gap. In a tentative step, the leg is then pulled back at some point during the searching movement and placed on the first instead of the second footbridge. This behaviour enables the animal to use a 'trial and error' strategy to search for a continuation of the path. In the flow chart (Fig. 10), antennal contact with the second footbridge is followed by finishing a tentative step, whereas front leg contact with the second footbridge is followed by finishing a gap-crossing step. Taking into account that gap-crossing behaviour is always completed after touching the second footbridge with an antenna, there might be a 'working memory' function involved in which the information 'path continues' is stored while the single leg is pulled back and possibly a more appropriate position is adopted. The observation that tentative steps occur rarely in the middle legs and never in the hind legs may also be based on this stored information.

Short steps occur in various situations during gap crossing, two of which have previously been identified as reflex reactions: the levator reflex (Dean and Wendler, 1982) and the

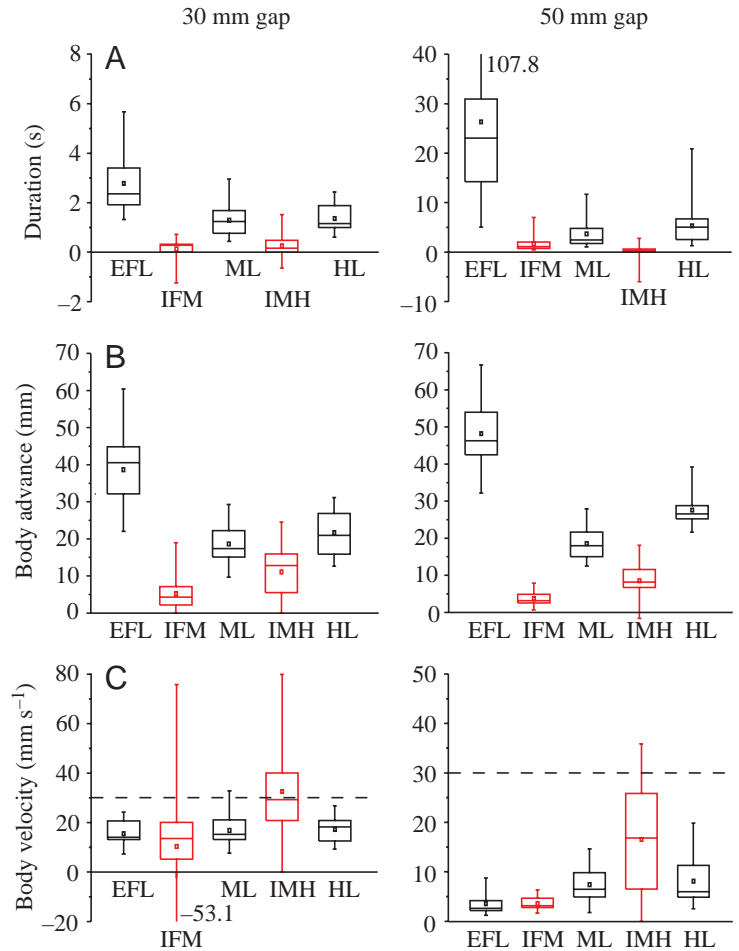

Fig. 7. Box and whisker plots of duration (A), body advance (B) and body velocity (C) of sections of the gap-crossing sequences (note the different scales for body velocity and duration). Red, IFM and IMH; black, EFL, ML, HL (see Fig. 1 for abbreviations); arithmetic means are added as squares. Left, 30 mm trials ($N=7$ animals, $n=15$ trials); right, 50 mm trials ($N=5$ animals, $n=10$ trials); mean walking velocity (30.0 ± 3.4 mm s⁻¹) calculated from ten sequences of undisturbed walking is added as a horizontal broken line in B. Negative duration values of interval sections indicate overlapping of gap-crossing steps of neighbouring leg pairs (30 mm: 5 cases in IFM, 5 cases IMH; 50 mm: 4 cases in IMH).

TOT (treading-on-tarsus) reflex (Graham, 1979; Schmitz and Hassfeld, 1989). The majority of the remaining short steps are performed by the middle and hind legs during section EFL or by the front legs throughout the entire sequence. This indicates that during EFL, the function of the short steps is to adjust the body position of the animal while examining the gap. The short steps performed by the middle and hind legs during section EFL may also be a part of the exploration behaviour, they support slow forward movement and slight side shifting of the body long axis during antennal and front leg searching. In the following sections, after the front legs have crossed the gap, short steps mainly occur in the front legs. Short steps performed by the front legs after reaching the second footbridge might represent tactile investigation of the ground to find an appropriate tarsus position. This is important because

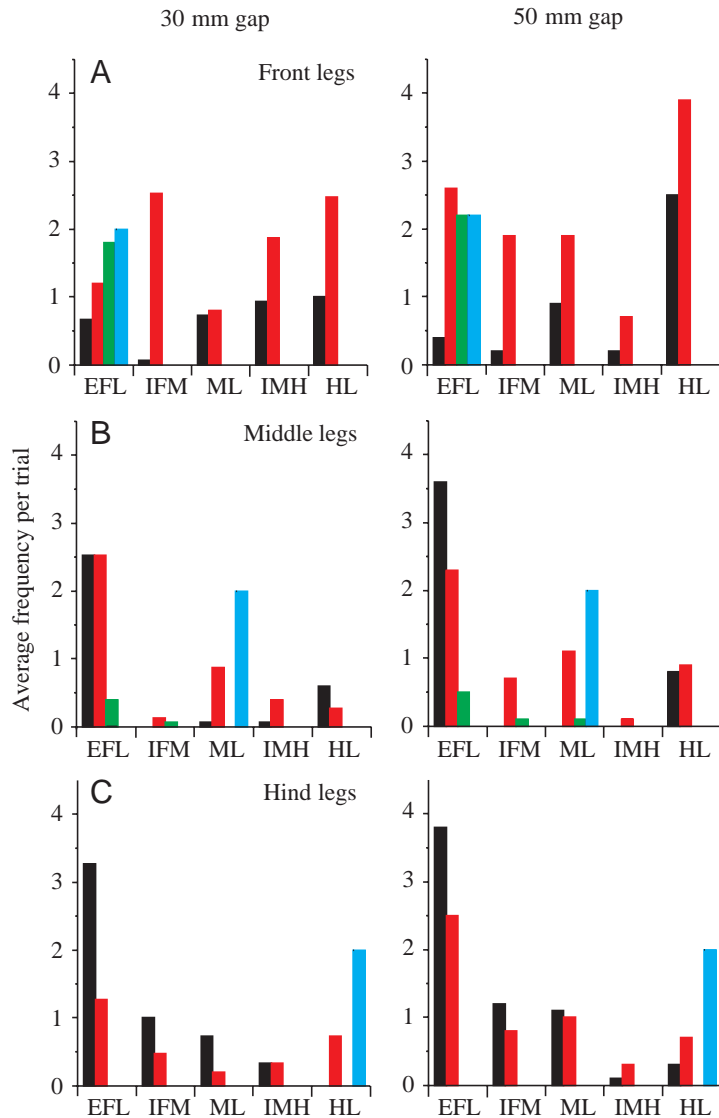

Fig. 8. Average frequency of different step types in the sections EFL to HL (see Fig. 1 for abbreviations). (A) Front legs, (B) middle legs, (C) hind legs, left: 30 mm trials ($N=7$ animals, $n=15$ trials), right: 50 mm trials ($N=5$ animals, $n=10$ trials). Black columns, normal walking steps; red columns, short steps; green columns, tentative steps; blue columns, gap-crossing steps.

the front legs have to support the main part of body weight during sections ML and HL. Pearson and Franklin (1984) have mentioned an increase of ‘local stepping’ in locusts when walking on a slippery surface. Stepping has also been observed in the cockroach after passive deflection of a leg (Zill, 1993). The described stepping strategies are not just used by invertebrates: cats show corrective response movements when losing ground (Gorassini et al., 1994) and perform a stumbling corrective reaction (Forsberg, 1979) that is similar to the levator reflex. In humans, different obstacle avoidance reactions result in lengthening or shortening a step if enough time is available to adapt the step length (Patla et al., 1991). If the obstacle is perceived within the same step cycle,

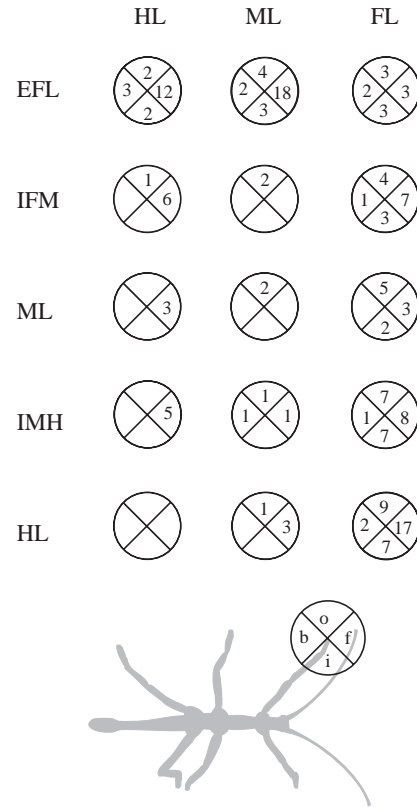

Fig. 9. Swing direction and temporal distribution of short steps. Swing direction (AEP relative to PEP) is defined in four groups (f, forward; b, backward; o, outward; i, inward; coordinate system is shown in the inset figure below). Temporal distribution is defined according to the five sections EFL to HL (see Fig. 1 for abbreviations); short steps caused by the levator or TOT-reflex and by clinging to the second footbridge have not been taken into account.

lengthening the step is the preferred strategy (Patla et al., 1999).

Comparing 30 mm to 50 mm gap-crossing trials revealed that most differences occur during section EFL. When climbing across a 50 mm gap, animals need ten times longer for the exploration phase than when climbing across a 30 mm gap, whereas they only need three times longer for the rest of the sequence (Fig. 7). Also, during EFL there are more different elements of behaviour and their order is more variable than during later parts of the sequence (Fig. 10). Comparison of the flow charts reveals further differences that seem to be caused by body geometry: the variety of body postures adopted by the insects while moving across the gap is more restrained in the 50 mm trials than in the 30 mm trials. Starting a gap-crossing step after finishing the intrasegmental leg one occurred only in the 30 mm trials, whereas a tendency for front leg gap-crossing steps and middle leg tentative steps to overlap was only observed in the 50 mm trials (Fig. 10).

Antennal movements are very distinct in *A. asperimus* and more clearly directed towards the ground than in *C. morosus*,

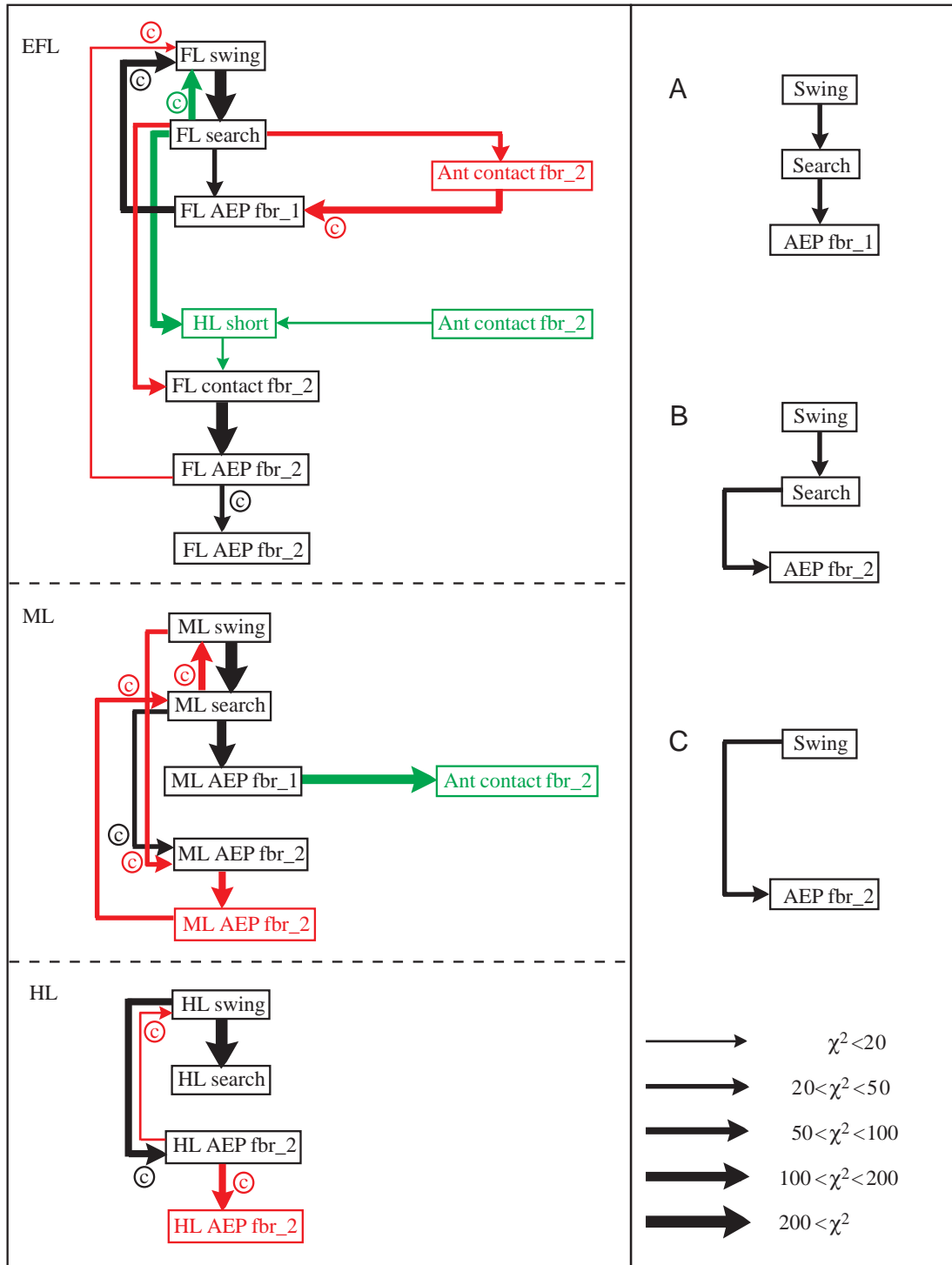

Fig. 10. Flow chart diagrams of gap-crossing behaviour. Arrows connect any two elements of behaviour that were performed in direct transition (bigrams), pointing from the first to the second element. The size of arrow (see key) represents the χ^2 -values of the corresponding bigrams (explained in the text; see Materials and methods). Arrows marked by **c** connect behavioural elements performed by limbs of contralateral body segments (e.g. left antenna and right front leg). Only bigrams that occurred more than twice and with higher probability than expected in a random distribution ($P \leq 0.001$) have been included in the flow chart. 'Typical' combinations that represent steps described in the text are schematically displayed on the right side: (A) tentative step, (B) gap-crossing step, (C) gap-crossing step without searching movement. Black, elements and transitions that occur in both the 30 mm and 50 mm trials; red, elements and transitions that occur only in the 30 mm trials; green, elements and transitions that occur only in the 50 mm trials; FL, front legs; ML, middle legs; HL, hind legs; Ant, antennal. For further abbreviations see Fig. 1 (sections of gap crossing) and Fig. 5 (ethogram; elements of behaviour used in the flow chart diagram are printed red).

with one up- and down-stroke and several ground contacts of each antenna per step cycle (Duerr and Blaesing, 2000; Duerr, 2001). Therefore, the first tactile perception of the gap could occur when one or both antennae miss ground contact after reaching the end of the first footbridge. It has been observed, however, that after this first antennal 'non-contact', the animal steps into the gap, which results in a 'non-contact' of the front leg. Only the latter, the front leg 'non-contact', is followed by a decrease in velocity of forward movement (Fig. 6). Slowing down seems to occur in response to stepping into the gap, but not in response to lowering the antenna into the gap. This suggests that antennal 'non-contact' does not influence the subsequent behaviour of the animal whereas 'non-contact' of the front leg does. The incident of 'non-contact', however, can only provide information in a situation in which the 'expectation of contact' has been thwarted. In the case of the antenna, therefore, expectation of ground contact seems to be absent, whereas ground contact seems to be expected at a certain height by the front leg, and thwarting of this expectation evokes a change of behaviour. The shift of the extreme positions of consecutive steps provides independent support for this interpretation, as shown by Blaesing and Cruse (2004).

How could the information necessary for ground expectation be received? It could be provided by the joint angles of the femur-tibia joint and the coxa-trochanter joint of the neighbouring legs. Passing a position with corresponding joint angles without sensing ground contact would evoke slowing down of stance movement. Alternatively, the joint angles of the same leg could be 'remembered' throughout the swing movement and used as a reference. In cats trained to walk on a flat surface, Gorassini et al. (1994) showed that extensor muscle excitation was similar to normal undisturbed stepping even when unexpectedly stepping into a hole. This is interpreted in such a way that an expectation of the ground substrate exists in the cat as well. It has been argued that this expectation is not based on leg position but on the lack of load on the supporting muscles (Hiebert et al., 1994).

Unlike antennal 'non-contact' during walking, physical contact of the antenna with the second footbridge during exploration has a clear impact on the subsequent behaviour. The results of the second experiment (Table 2) suggest that when a stick insect is reaching the end of a walking path, information about a continuation of the path is not gained by vision, even though *A. asperrimus* shows orientation behaviour towards certain visual stimuli (Frantsevich and Frantsevich, 1996). The observation that animals only continue gap-crossing behaviour if they receive tactile input from touching the far edge of the gap with an antenna or front leg independent of the state of their visual system indicates that vision alone does not provide sufficient information. The tactile stimulus of touching the far edge of the gap with an antenna provides the animal with sufficient information about the existence of a far edge and, inherently, about gap size to climb across the gap successfully. After the far edge has been touched by an antenna, locomotion towards this stimulus is always continued, and the gap-crossing sequence is not abandoned any more.

This indicates that if an animal can reach a footbridge with its flagellum while probing its environment, it can also reach it with its front legs if it adopts a position in which its body centre of mass is pushed forward even past the edge of the supporting footbridge. The male specimens of *A. asperrimus* used in this study were able to climb across gaps of up to 50 mm (Table 1), which is equivalent to their body length. When trying to cross larger gaps, they could hardly reach the far edge with their antennae and therefore failed to receive information about the far side of the gap. It could be argued that the additional distance that can be reached by the antenna but barely by the front leg (about 5–10 mm in *A. asperrimus*) allows the animal to 'plan ahead' and exploit specific inconvenient body postures to reach far ground. In cockroaches, anticipatory rearing of the thorax after detecting an obstacle with the antenna has been observed (Watson et al., 2002; Tryba and Ritzman, 2000). Animals that do not have intact antennae might lack the chance to 'plan ahead' as they have to rely on front leg exploration. To approach this issue, animals with artificially elongated flagella (see Camhi and Johnson, 1999), short but intact front legs or a shifted centre of mass (weights attached to the thorax or abdomen), could be tested in the same task.

Immediate slowing down of forward movement occurs in response to stepping into the gap, i.e. 'non-contact' of a front leg (Fig. 6), and further forward movement consists of single bouts while the gap is investigated by explorative movements of the antennae and front legs. Decrease of velocity helps to maintain static stability, as has been shown by Cymbalyuk et al. (1998) who, in a simulation study, investigated body stability when starting to walk from different leg configurations. Locusts have been reported to stop before stepping across a 10 mm ditch (front leg step amplitude: 20 mm), adjust their body position by hind leg flexing and middle leg stepping and perform extensive searching movements with the front legs (Pearson and Franklin, 1984). No stop has been reported for *C. morosus* when walking across a 10 mm ditch (Cruse, 1979) or a 20 mm gap (Duerr, 2001).

After swinging into the gap, the legs perform various searching movements before touching the second footbridge. In locusts, searching movements of the front legs after stepping into a gap have been described qualitatively as cycles of elevation and depression (Pearson and Franklin, 1984). An example of searching movements in *C. morosus* and their simulation has been given by Duerr (2001). At the end of the searching movement, the tarsus is often pulled upwards after hitting the second footbridge from below, a reaction that has been described as levator reflex (Dean and Wendler, 1982) and has also been found in the same context in locusts when stepping across a ditch (Pearson and Franklin, 1984).

The results described above suggest that most adaptations of walking behaviour to the gap-crossing situation occur during the interval of antennal and front leg exploration of the gap. Lowering an antenna into the gap does not influence the subsequent behaviour whereas stepping into the gap with a front leg initiates slowing down of walking velocity. Tactile contact of the antenna or a front leg with the second footbridge

has been found to represent a 'point of no return' in the gap-crossing sequence. After this incident, animals did not terminate gap crossing and switch to a different behaviour but always 'struggled' until they could reach the second footbridge with a front leg. After the first tactile contact of an antenna with the second footbridge and before the front legs reach the second footbridge, the sequence of behaviour still includes loops, especially in the form of front leg tentative steps. After reaching the second footbridge with the front legs, the gap-crossing sequence becomes less variable, the animals reliably succeeding in stepping across the gap with their other leg pairs in all observed trials. The order of single elements of behaviour within the sequence is less variable when crossing a large gap of approx. their body length than when crossing a comparably small gap.

These observations emphasize that for locomotion in a complex environment, tactile exploration can be a valuable means of orientation. Even for embodied artificial systems, tactile exploration is useful as an alternative or in addition to a visual system that is more costly and depends on light conditions. Antennae are not necessarily needed, an agent with six or more legs can use its front legs as tactile probes. A combination of antennae and front legs, however, offers more elaborate possibilities for utilizing and combining tactile information. In the stick insect, an expectation of ground contact is made by the front leg, but not by the antenna. The antenna, however, provides global information about the general possibility of continuing the path and therefore a means of 'planning ahead'. We would like to argue that these strategies can be used by an artificial agent to move about in an unknown three-dimensional environment even without sight. Vision appears rather to be used for gaining information at longer distances. Appropriate simulation studies are currently being carried out by our work group.

This work was supported by grant no Cr 58/9-3 of the DFG and the graduate programme 'Verhaltensstrategien und Verhaltensoptimierung' (DFG).

References

- Beer, R. D., Quinn R. D., Chiel, H. J. and Ritzman, R. E. (1997). Biologically inspired approaches to robotics. What can we learn from insects? *Commun. ACM* **40**, 31-38.
- Berridge, K. (1990). Comparative fine structure of action: Rules of form and sequence in the grooming patterns of six rodent species. *Behavior* **113**, 21-56.
- Blaesing, B. and Cruse, H. (2004). Mechanisms of stick insect locomotion in a gap crossing paradigm. *J. Comp. Physiol. A*, in press.
- Bradley, D.W. and Bradley, R. A. (1983). Application of sequence comparison to the study of bird songs. In *Time Warps, String Edits and Macromolecules* (ed. Joseph Kruskal and David Sankoff), pp. 189-209. Reading, MA: Addison Wesley.
- Bragg, P. (2001). *Phasmids of Borneo*, pp. 103-108. Kota Kinabalu: Natural History Publications.
- Bruski, C. A. and Dunham, D. W. (1990). Antennal waving in the crayfish *Orconectes rusticus* (Girard 1852) (Decapoda, Astacidea). *Crustaceana* **58**, 8-87.
- Burrows, M. and Morris, O. (2002). Jumping in a winged stick insect. *J. Exp. Biol.* **205**, 2399-2412.
- Camhi, J. H. and Johnson, E. N. (1999). High-frequency steering maneuvers mediated by tactile cues: antennal wall-following in the cockroach. *J. Exp. Biol.* **202**, 631-643.
- Cowan, N. J., Ma, E. J., Cutkosky, M. and Full, R. J. (2003). A biologically inspired passive antenna for steering control of a running robot. In *Springer Tracts in Advanced Robotics* (ed. B. Siciliano, O. Khatib and F. C. A. Groen). Heidelberg, Springer.
- Cruse, H. (1976a). The control of the body position in the stick insect (*Carausius morosus*), when walking over uneven surfaces. *Biol. Cybern.* **24**, 25-33.
- Cruse, H. (1976b). The function of the legs in the free walking stick insect, *Carausius morosus*. *J. Comp. Physiol.* **112**, 235-262.
- Cruse, H. (1979). The control of the anterior extreme position of the hind leg of a walking insect *Carausius morosus*. *Physiol. Entom.* **4**, 121-124.
- Cruse, H. (2001). Robotic experiments on insect walking. In *Artificial Ethology* (ed. O. Holland and D. McFarland), pp. 122-139. Oxford: Oxford University Press.
- Cruse, H. and Frantsevich, L. (1997). The stick insect *Obrimus asperrimus* (Phasmida, Bacillidae) walking on different surfaces. *J. Insect Physiol.* **43**, 447-455.
- Cymbalyuk, G. S., Borisyuk, R. M., Müller-Wilm, U. and Cruse, H. (1998). Oscillatory networks controlling six-legged locomotion. Optimization of model's parameters. *Neural Networks* **11**, 1449-1460.
- Dean, J. and Wendler, G. (1982). Stick insect walking on a wheel: Perturbations induced by obstruction of leg protraction. *J. Comp. Physiol. A* **148**, 195-207.
- Duerr, V. (2001). Stereotypic leg searching-movements in the stick insect: Kinematic analysis, behavioural context and simulation. *J. Exp. Biol.* **204**, 1589-1604.
- Duerr, V. and Authmann T. (2002). Insect curve walking revisited: Transitions versus steady states. *Zoology* **105** Supplement V (DZG 95.1), 66.
- Duerr, V. and Blaesing, B. (2000). Antennal movements of two stick insect species: Spatio-temporal coordination with leg movements. *Zoology* **103** Supplement III (DZG 93.1), 17.
- Duerr, V. and Krause, A. (2002). Design of a biomimetic active tactile sensor for legged locomotion. In *Proc. 5th Int. Conf. Climbing and Walking Robots (CLAWAR 2002)* (ed. P. Bidaud and F. Ben Amar), pp. 255-262. London: Professional Engineering Publishing.
- Forsberg, H. (1979). Stumbling corrective reaction: a phase-dependent compensatory reaction during locomotion. *J. Neurophysiol.* **42**, 936-953.
- Frantsevich, I. and Frantsevich, L. (1996). Space constancy in form perception by the stick insect. *Naturwissenschaften* **83**, 323-324.
- Full, R. J., Blickhan, R. and Ting, L. H. (1991). Leg design in hexapedal runners. *J. Exp. Biol.* **158**, 369-390.
- Graham, D. (1979). Effects of circum-oesophageal lesion on the behaviour of the stick insect *Carausius morosus*. 2. Changes in walking co-ordination. *Biol. Cybern.* **32**, 147-152.
- Gorassini, M. A., Prochazka, A., Hiebert, G. W. and Gauthier, M. J. A. (1994). Corrective responses to loss of ground support during walking. I. Intact cats. *J. Neurophysiol.* **71**, 603-610.
- Hiebert, G. W., Gorassini, M. A., Jiang, W., Prochazka, A. and Pearson, K. G. (1994). Corrective responses to loss of ground support during walking. II. Comparison of intact and chronic spinal cats. *J. Neurophysiol.* **71**, 611-622.
- Hoelldobler, B. and Wilson, E. O. (1990). *The Ants*. Cambridge, Mass: The Belknap Press of Harvard University Press.
- Hoffmann, A. A. (1987). A laboratory study of male territoriality in the sibling species *Drosophila melanogaster* and *Drosophila simulans*. *Anim. Behav.* **35**, 807-818.
- Hofmann, H. A. and Schildberger, K. (2001). Assessment of strength and willingness to fight during aggressive encounters in crickets. *Anim. Behav.* **62**, 337-348.
- Honegger, H.-W. (1981). A preliminary note on a new optomotor response in crickets: Antennal tracking of moving targets. *J. Comp. Physiol. A* **142**, 419-421.
- Immelmann, K. and Beer, C. (1989). *A Dictionary of Ethology*. Cambridge: Harvard University Press.
- Jindrich, D. L. and Full, R. J. (1999). Many-legged maneuverability: dynamics of turning in hexapods. *J. Exp. Biol.* **202**, 1603-1623.
- Jurafsky, D. and Martin, J. H. (2000). *Speech and Language Processing: An Introduction to Natural Language Processing, Computational Linguistics, and Speech Recognition*. Upper Saddle River, NJ: Prentice Hall.
- Marigold, D. S. and Patla, A. E. (2002). Strategies for dynamic stability

- during locomotion on a slippery surface: Effects of prior experience and knowledge. *J. Neurophysiol.* **88**, 339-353.
- Marigold, D. S., Bethune, A. J. and Patla, A. E.** (2003). Role of the unperturbed limb and arms in the reactive recovery response to an unexpected slip during locomotion. *J. Neurophysiol.* **89**, 1727-1737.
- Okada, J. and Toh, Y.** (2001). Peripheral representation of antennal orientation by the scapal hair plate of the cockroach *Periplaneta americana*. *J. Exp. Biol.* **204**, 4301-4309.
- Patla, A. E., Prentice, S. D., Robinson, C. and Neufeld, J.** (1991). Visual control of locomotion: strategies for changing direction and for going over obstacles. *J. Exp. Psych. Hum. Percep. Perf.* **17**, 603-634.
- Patla, A. E., Prentice, S. D., Rietdyk, S., Allard, F. and Martin, C.** (1999). What guides the selection of alternate foot placement during locomotion in humans? *Exp. Brain Res.* **128**, 441-450.
- Pearson, K. G. and Franklin, R.** (1984). Characteristics of leg movement and patterns of coordination in locusts walking on rough terrain. *Int. J. Robot. Res.* **3**, 101-112.
- Pick, S. and Strauss, R.** (2003). Towards the neural substrate underlying insect climbing behavior – a high-speed 3D-video analysis of normal and mutant flies. In *The neurosciences From Basic Research to Therapy. Proc. 5th Meeting German Neurosci. Soc. 2003, 29th Göttingen Neurobiol. Conf.* (ed. N. Elsner and G. W. Kreutzberg), pp. 217. Stuttgart: Thieme.
- Ritzman, R. E., Quinn, R. D., Watson, J. T. and Zill, S. N.** (2000). Insect walking and biorobotics: A relationship with mutual benefits. *BioScience* **50**, 23-33.
- Sandeman, D. C. and Varju, D.** (1988). A behavioural study of tactile localisation in the crayfish *Cherax destructor*. *J. Comp. Physiol. A* **163**, 525-536.
- Schmitz, J. and Hassfeld, G.** (1989). The treading-on-tarsus reflex in stick insects: Phase dependence and modifications of the motor output during walking. *J. Exp. Biol.* **143**, 373-388.
- Tinbergen, N.** (1951). *The Study of Instinct*. Oxford: Clarendon Press.
- Tryba, A. K. and Ritzman, R. E.** (2000). Multi-joint coordination during walking in the *Blaberus* cockroach. I. kinematics and electromyograms. *J. Neurophysiol.* **83**, 3323-3336.
- Watson, J. T., Ritzmann, R. E., Zill, S. N. and Pollack, A. J.** (2002). Control of obstacle climbing in the cockroach *Blaberus discoidalis* I: Kinematics. *J. Comp. Physiol. A* **188**, 39-53.
- Zeil, J., Sandeman, R. and Sandeman, D. C.** (1985). Tactile localisation: the function of active antennal movements in the crayfish *Cherax destructor*. *J. Comp. Physiol. A* **157**, 606-617.
- Zill, S. N.** (1993). Load compensatory reactions in insects: Swaying and stepping strategies in posture and locomotion. In *Biological Neuronal Networks in Invertebrate Neuroethology and Robotics* (ed. R. D. Beer, R. E. Ritzman and T. McKenna), pp. 43-68. San Diego: Academic Press.